

# AutoCad

## Basic Tutorial

# Launching AutoCad

1. Start
2. 3D and CAD
3. AutoCad

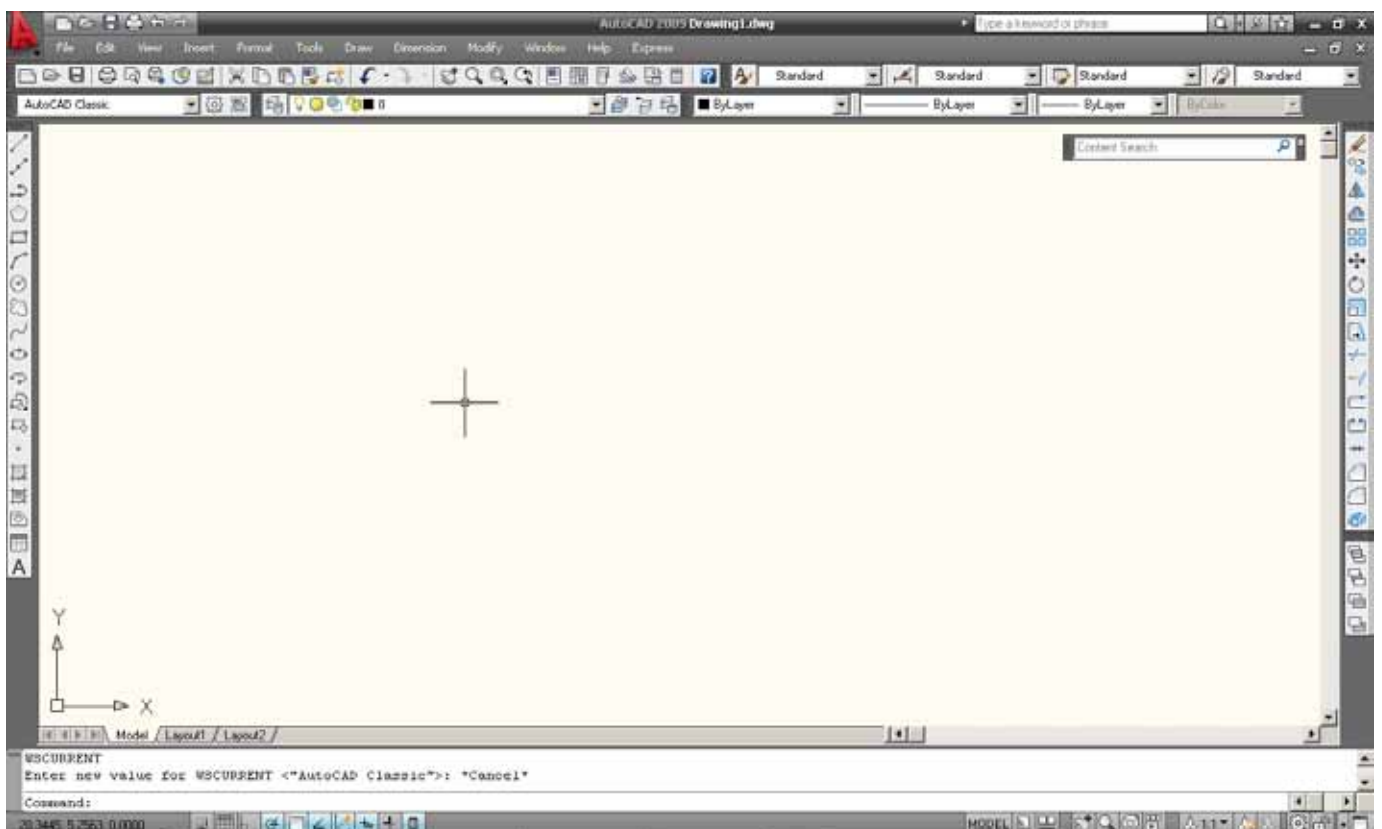

# Typing Commands

## Typing a Command

All AutoCAD commands can be typed in at the command line. Many commands also have one or two letter aliases that can also be typed as shortcuts to the commands.

1. Type the desired command at the command prompt.

Command : **LINE**

or

2. Type the command's alias. Command: **L**

3. Press **ENTER/Space** to end.

4. Type an option at the command prompt.

**TIP:** Many AutoCAD commands require you to press ENTER to complete the command. You know you are no longer in an AutoCAD command when you see a blank command line.

## Reissuing the Last Command

The last used AutoCAD command can be re-entered by one of the following three methods of ENTER. The ENTER key on the keyboard will always act as ENTER, the SPACEBAR and RIGHT MOUSE will act as enter most of the time (exceptions include placing TEXT).

1. Press the **ENTER** key on the keyboard

or

2. Press the **Space bar** on the keyboard.

or

3. Click the **right** mouse button.

# Pointing Device (Mouse)

AutoCAD uses either a mouse or digitizing tablet to select objects in a drawing.

## Left Mouse Button

Used to pick or select objects

1. Click the left mouse button to select an object area in the drawing.
2. Press **ESC** twice to deselect an object (or to cancel a command).

## Right Mouse Button

Used to enter a command, repeat last command, or access shortcut menus.

1. Click the right mouse button.

### TIPS:

- SHIFT + the right mouse button brings up the object snap menus.
- Various screen locations for the mouse brings up different menus. • menus.

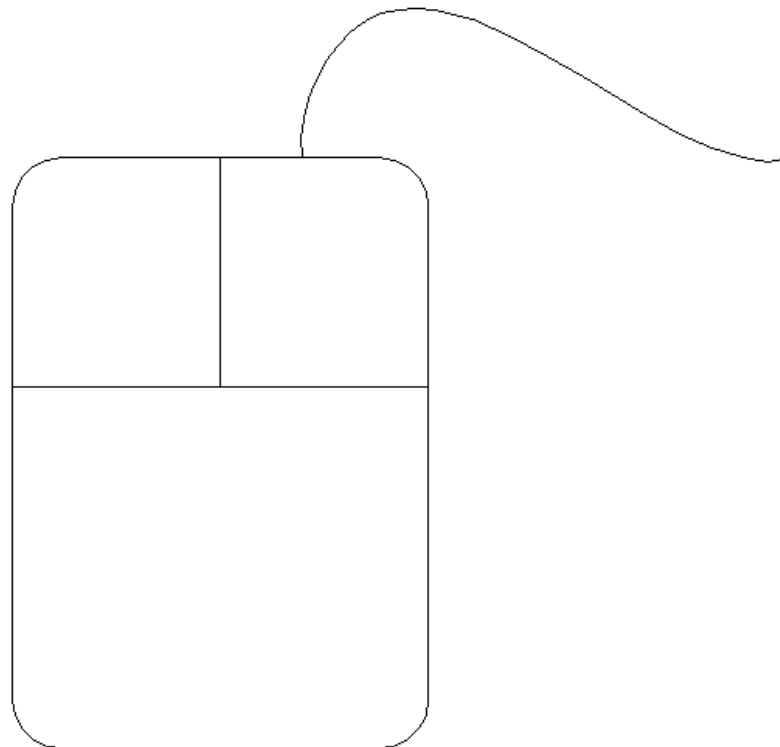

## 5.2 PAN

Shifts the location of a view.

1. **Choose** View, Pan.

**or**

2. **Click** the Pan icon. 

**or**

3. **Type** PAN from the command prompt.

Command: **PAN** or **P**

### TIPS:

- While in the PAN command, click with the right mouse button to see the following menu.

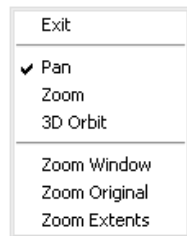

- Panning can also be done by using the window scroll bars

## 5.1 ZOOM

Increases or decreases the apparent size of objects in the current viewport

1. **Choose** View, Zoom.  
**or**
2. **Click** a Zoom icon. 
3. **Type** ZOOM at the command prompt.  
Command: **Zoom** or **Z**
4. **Type** One of the following zoom options:

The following are basic zoom options:

- All** Places entire drawing (all visible layers) on display at once. Forces a regeneration.
- Extents** Displays current drawing content as large as possible.
- Previous** Restores previous view.
- Window** Designates rectangular area to be drawn as large as possible.
- Number** Magnification relative to ZOOM All display
- Number X** Magnification relative to current display (1X)
- Center** Specifies center point and new display height.
- Dynamic** Permits you to pan a box representing the viewing screen around the entire generated portion of the drawing and enlarge or shrink it.

### TIPS:

-While in the ZOOM command, click with the right mouse button to see the menu to the right.

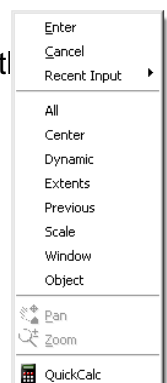

## 2.2 Creating a New Drawing

### NEW Command

*Creates a new drawing file.*

1. **Choose** File, New.  
**or**
2. **Press** CTRL + N  
**or**
3. **Click** the New icon.  
**or**
4. **Type** NEW at the Command prompt.  
Command: **NEW**
5. **Choose** One of the options for creating a new drawing.
6. **Click** The OK button.
7. **Save** the drawing as another name.

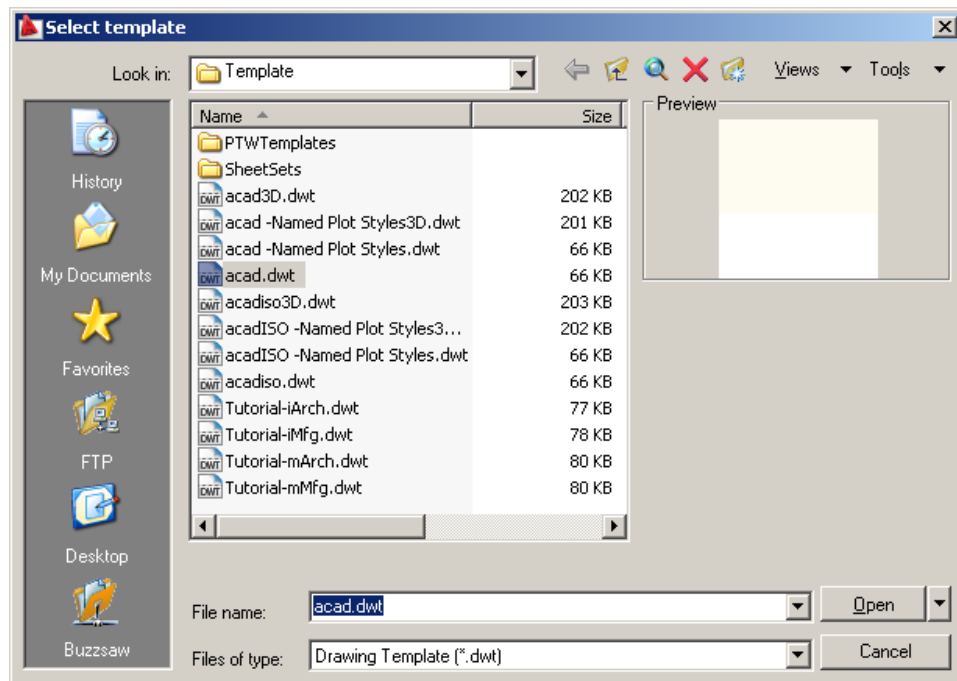

**TIP:**

New drawings can also be created from Template Files.

## 1.11 Undo and Redo

Reverses the last action.

1. Choose **Edit, Undo**.  
or
2. Click the Undo icon.   
or
3. Press **CTRL + Z**.
4. Type U at the command prompt to undo the last command.  
Command: **U**

### Redo

Reverses the effects of a single UNDO or U command.

1. Choose **Edit, Redo**.  
or
2. Click the Redo icon.   
or
3. Type REDO at the command prompt to redo the last undo command.  
Command: **REDO**



TIPS:

-UNDO has no effect on some commands and system variables, including those that open, close, or save a window or a drawing, display information, change the graphics display, regenerate the drawing, or export the drawing in a different format.

-REDO must immediately follow the U or UNDO command.



## 1.12 Function Keys and Accelerator Keys

F1	Displays Help
F2	Toggles Text Window
F3	Toggles OSNAP
F4	Toggles TABMODE
F5	Toggles ISOPANE
F6	Toggles UCSDETECT
F7	Toggles GRIDMODE
F8	Toggles ORTHOMODE
F9	Toggles SNAPMODE
F10	Toggles Polar Tracking
F11	Toggles Object Snap Tracking
F12	Toggles Dynamic Input

ALT+F11	Displays the Visual Basic Editor
ALT+F8	Displays the Macros dialog box
CTRL+0	Toggles Clean Screen
CTRL+1	Toggles Properties palette
CTRL+2	Toggles DesignCenter
CTRL+3	Toggles the Tool Palettes Window
CTRL+4	Toggles Sheet Set Manager
CTRL+5	Toggles Info Palette
CTRL+6	Toggles dbConnect Manager
CTRL+7	Toggles Markup Set Manager
CTRL+8	Toggles the QuickCalc calculator palette
CTRL+9	Toggles the command window
CTRL+A	Selects objects in drawing
CTRL+SHIFT+A	Toggles Groups
CTRL+B	Toggles Snap
CTRL+C	Copies objects to Clipboard
CTRL+SHIFT+C	Copies objects to Clipboard with Base Point
CTRL+D	Toggles Dynamic UCS
CTRL+E	Cycles through isometric planes
CTRL+F	Toggles running object snaps
CTRL+G	Toggles Grid
CTRL+H	Toggles PICKSTYLE
CTRL+I	Toggles COORDS

CTRL+J	Repeats last command
CTRL+L	Toggles Ortho mode
CTRL+M	Repeats last command
CTRL+N	Creates a new drawing
CTRL+O	Opens existing drawing
CTRL+P	Prints current drawing
CTRL+R	Cycles layout viewports
CTRL+S	Saves current drawing
CTRL+SHIFT+S	Brings up the Save As dialog box
CTRL+T	Toggles Tablet mode
CTRL+V	Pastes data from Clipboard
CTRL+SHIFT+V	Pastes data from Clipboard as a Block
CTRL+X	Cuts objects to Clipboard
CTRL+Y	Cancel the preceding Undo action
CTRL+Z	Reverses last action
CTRL+[	Cancel current command
CTRL+\	Cancel current command
CTRL+PAGE UP	Moves to the next layout tab to the left of the current tab
CTRL+PAGE DOWN	Moves to the next layout tab to the right of the current tab

## 2.1 Open Existing Drawings

1. **Choose** File, OPEN.  
or
2. **Press** CTRL + O.  
or
3. **Click** the OPEN icon.  
or
4. **Type** OPEN at the command prompt.  
Command: **OPEN**
5. **Press** ENTER
6. **Double Click** the desired directory to find the drawing to open.
7. **Click** the drawing name to open.
8. **Click** The OK button.

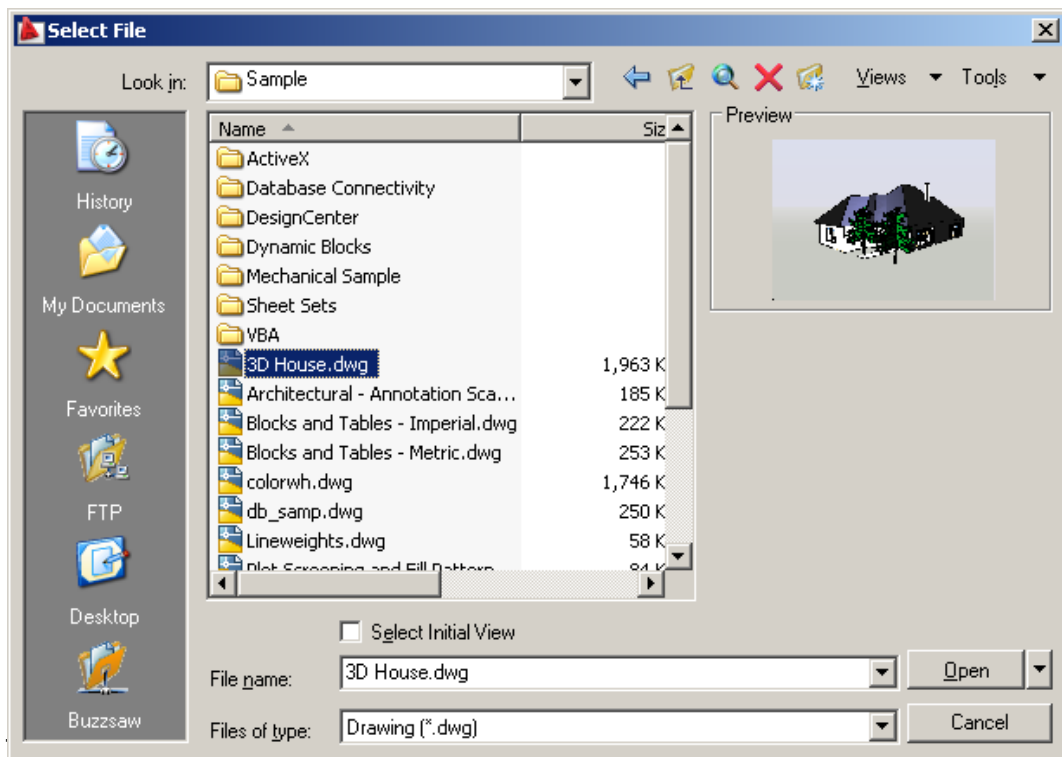

-Preview shows a bitmap image of the drawing selected. This image is the view that was last saved in the drawing. It will not show a preview of drawings saved before R13 AutoCAD.

## Quick Save

The QSAVE command is equivalent to clicking Save on the File menu.

If the drawing is named, AutoCAD saves the drawing using the file format specified on the Open and Save tab of the Options dialog box and does not request a file name. If the drawing is unnamed, AutoCAD displays the Save Drawing As dialog box (see SAVEAS) and saves the drawing with the file name and format you specify.

1. **Press** CTRL + S.  
**or**
2. **Click** the Save icon.   
**or**
3. **Type** QSAVE at the command prompt,  
Command:**QSAVE**

### TIPS:

Drawings can be saved as different versions of AutoCAD (e.g. R13, R14, R 2000, etc.)

### AutoSave settings under Tools, Options...

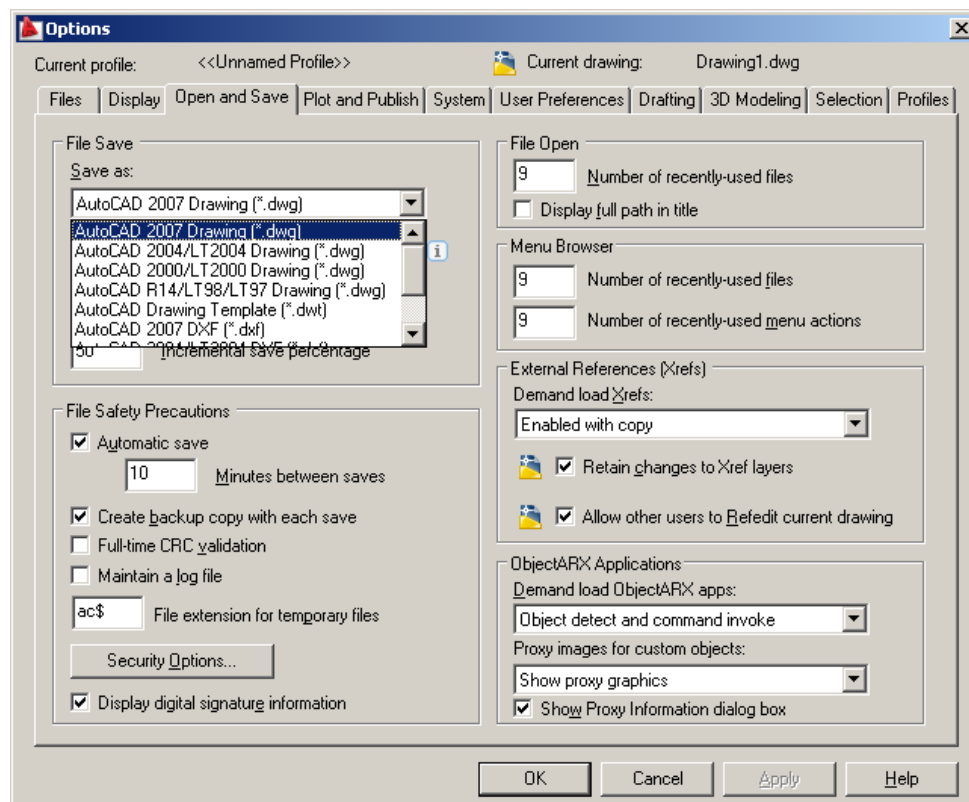

# Useful Commands

## 7.1 Running Object Snaps

An object snap mode specifies a snap point at an exact location on an object. OSNAP specifies running object snap modes, which remain active until you turn them off.

1. **Choose** Tools, Drafting Settings...  
**or**
2. **Type** DDOSNAP at the command prompt  
Command: **DDOSNAP**  
**or**
3. **Click** OSNAP on the Status Bar.
4. **Right Click** the Object Snap TAB.
5. **Choose** an object snap to turn ON/OFF from the dialog box.

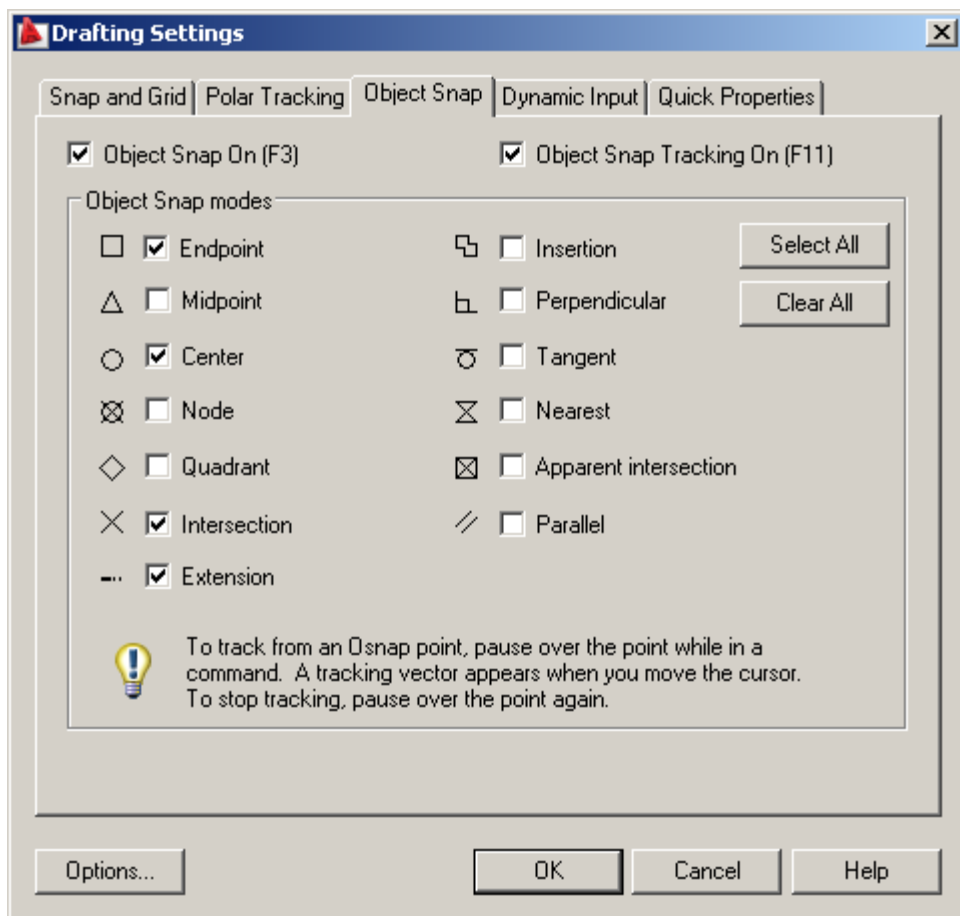

# AutoCAD 2D Tutorial

---

## UNITS Command 8.5

1. **Choose** Format, Units...  
or
2. **Type** DDUNITS at the command prompt.  
Command: **DDUNITS** or **UN**
3. **Choose** a units and angle setting.
4. **Choose** a precision setting.

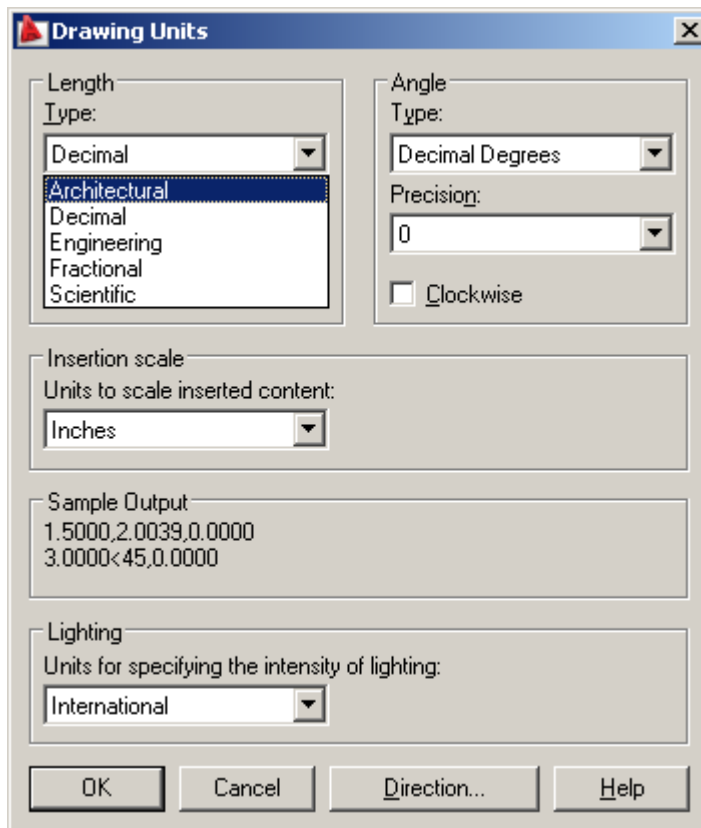

## 3.1 Line Command

Creates single straight line segments

1. **Choose** Draw, Line.  
**or**
2. **Click** the Line icon.   
**or**
3. **Type** LINE from the command prompt  
Command: **LINE** or **L**
4. **Press** ENTER
5. **Pick** From point: (**point**)
6. **Pick** Specify next point or [Close/Undo]:(**point**)
7. **Pick** Specify next point or [Close/Undo]:(**point**)
8. **Press** ENTER to end line sequence  
**or**
9. **Type** U to undo the last segment  
To point: **U** (undo)  
**or**
10. **Type** C to create a closed polygon  
To point : **C** (close)

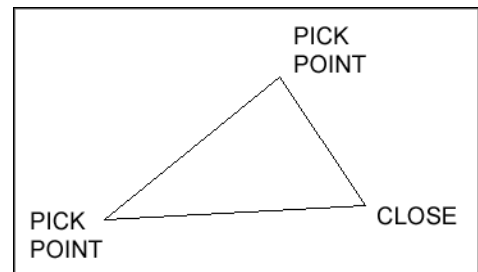

TIPS:

- You can continue the previous line or arc by responding to the From point: prompt with a space or ENTER.
- Choose the right mouse button for the line pop-up menu to appear while in the line command

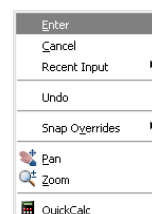

# AutoCAD 2D Tutorial

---

## Pline Command 15.1

A polyline is a connected sequence of line segments created as a single object. You can create straight line segments, arc segments, or a combination of the two.

1. **Choose** Draw, Polyline.  
**or**
2. **Pick** the Pline icon. 
3. **Type** PLINE at the command prompt  
Command : **PLINE** or **PL**
4. **Pick** A point on the drawing to start the polyline  
From point:(**select**)
5. **Type** One of the following options  
Arc/Close/Halfwidth/Length/Undo/Width/<endpoint of line>:  
**or**
6. **Pick** A point to continue drawing  
Arc/Close/Halfwidth/Length/Undo/Width/<endpoint of line>: (**pick point**)

*Polyline as one segment*

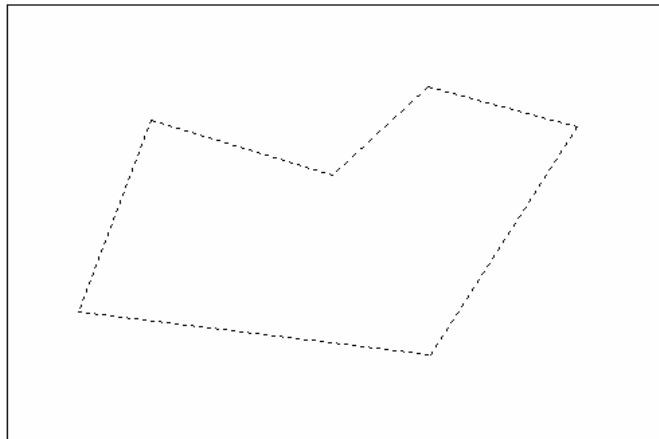



## 3.4 Orthogonal Lines

Controls lines from being drawn at various angles to straight lines. When the snap grid is rotated, ortho mode rotates accordingly.

1. **Press** Function Key **F8**.  
**or**
2. **Double Click** ORTHO from the Status Bar.  
**or**
3. **Press** CTRL + L.

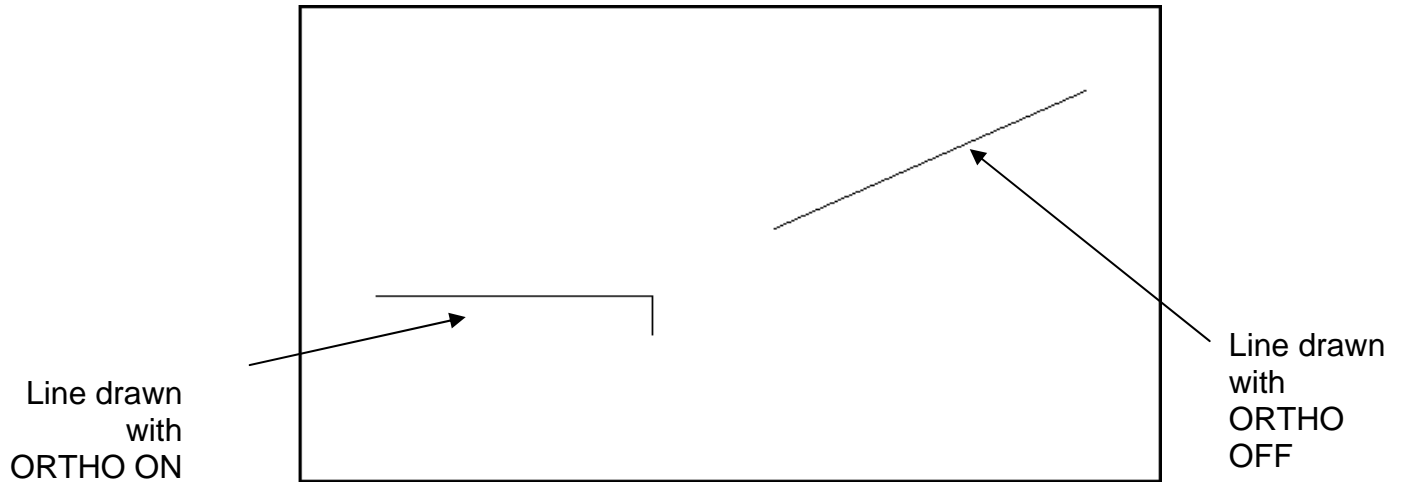

# AutoCAD 2D Tutorial

---

## Rectangle 16.2

1. **Choose** Draw, Rectangle.  
**or**
2. **Click** the Rectangle icon. 
- or**
3. **Type** Rectang at the command prompt Command:  
RECTANG Chamfer/Elevation/Fillet/Thickness/Width/  
<First corner>:
4. **Pick** first corner.
5. **Pick** other corner or type coordinates (**i.e. @4,2**).

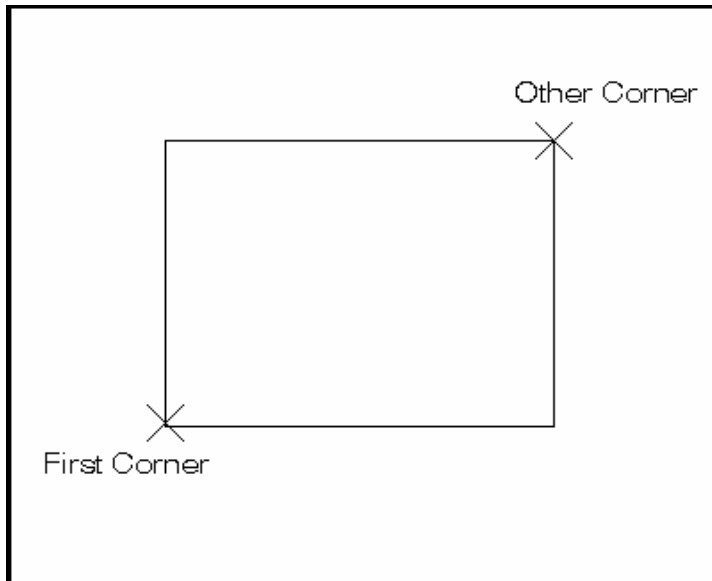

# 3.6 Circles

## Circle Command

1. **Choose** Draw, Circle.  
**or**
2. **Click** the Circle icon. 
3. **Type** CIRCLE at the command prompt.  
Command: **CIRCLE**
4. **Type** One of the following options:  
3P/2P/TTR/⟨⟨center point⟩⟩:  
**or**
5. **Pick** A center point.
6. **Type** A radius or diameter.  
**or**
7. **Pick** A radius or diameter  
Diameter/⟨⟨radius⟩⟩:

*Circle, Center Radius*

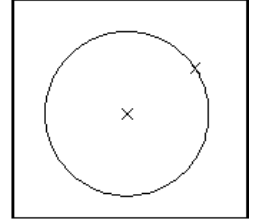

*Circle, Center Diameter*

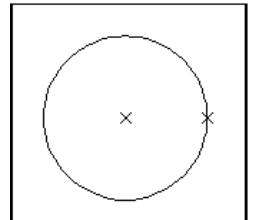

*Circle, Tangent, Tangent Radius*

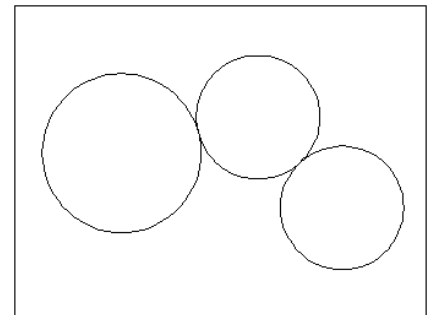

*Circle, Tangent, Tangent, Tangent*

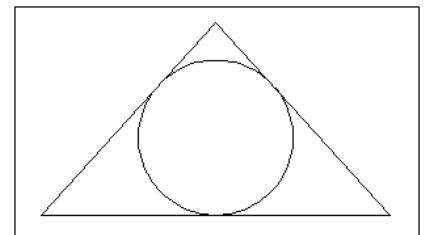

### TIPS:

- To create circles that are the same size, press ENTER when asked for the circle radius.
- When selecting a circle with a pickbox, be sure to select the circumference of the circle.

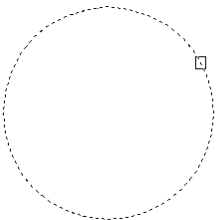

## 3.7 Arc Command

1. **Choose** Draw, Arc.  
or
2. **Click** the Arc icon. 
- or
3. **Type** ARC at the command prompt  
Command: **ARC**
4. **Draw** One of the arcs.

### TIPS:

-Except for 3 point arcs, arcs are drawn in a COUNTERCLOCKWISE direction.

- While in the arc command, press the right mouse button to select the following options for arcs:

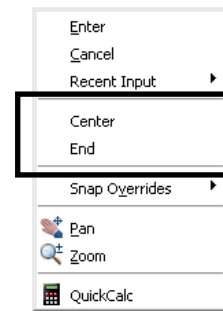

### Arc Examples

3 point arc

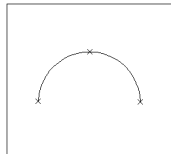

Start ,center, chord length

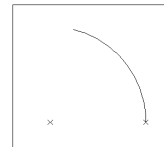

start, center, end

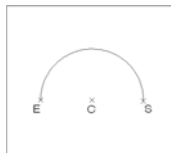

Start, end, radius

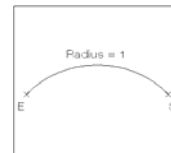

Start , center, included angle

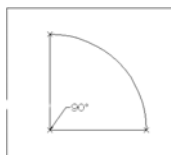

Start, end, direction

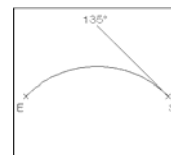

# AutoCAD 2D Tutorial

## Spline 16.3

The SPLINE command creates a particular type of spline known as a nonuniform rational B-spline (NURBS) curve. A NURBS curve produces a smooth curve between control points

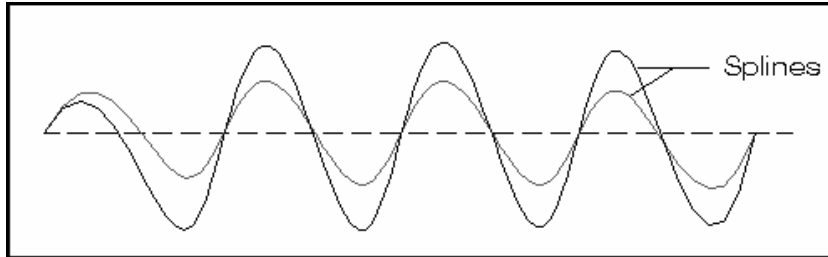

1. **Choose** Draw, Spline.  
or
2. **Click** the Spline icon.   
or
3. **Type** SPLINE at the command prompt  
Command: **SPLINE**
4. **Pick** A start point for the spline  
Object / <Enter first point>: (**pick point**)
5. **Pick** Points until you are done drawing splines  
Enter point: (**pick points**)
6. **Press** Enter or close to complete the spline
7. **Pick** Starting tangent point for the spline  
Enter start tangent (**pick point**)
8. **Pick** Ending tangent point for the spline  
Enter end tangent: (**pick point**)

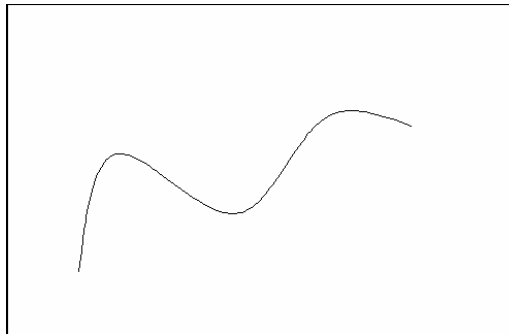

# Editing

# AutoCAD 2D Tutorial

## Editing Polylines 15.2

1. **Choose** *Modify, Polyline.*  
**or**
2. **Pick** the Pedit icon from the Modify II toolbar. 
3. **Type** PEDIT at the command prompt  
Command: **PEDIT**
4. **Pick** Pick a polyline to edit  
Select Polyline:(**pick**)
5. **Type** One of the following options:Close/Join/ Width/Edit vertex/FitCurve/Spline/Curve/Decurve/Undo/eXit

### PEDIT options:

- Close** Closes open polyline segments
- Join** Connects polylines, lines, and arcs to existing polylines.
- Width** Changes the width for all polyline segments.
- Fit curve** Creates curved arc segments around pline vertices at the direction you specify.
- Spline Curve** Creates a curve through control points on a polyline.
- Decurve** Straightens curved segments.
- Edit Vertex** Displays the following Edit Vertex Options:

*Polyline width change*

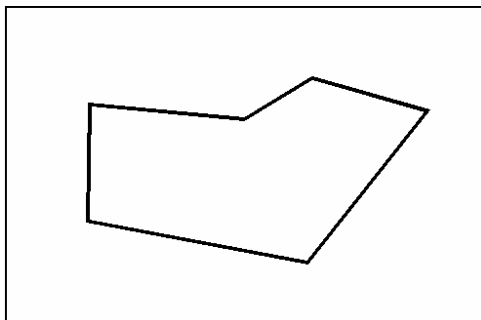

*Splined Polyline*

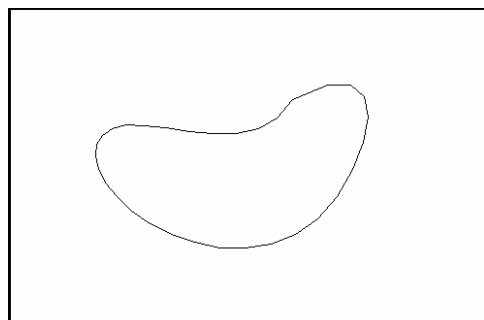

# AutoCAD 2D Tutorial

---

## Move Command 10.1

1. **Choose** Modify, Move.  
or
2. **Click** the Move icon. 
- or
3. **Type** MOVE at the command prompt  
Command: **MOVE or M**
4. **Pick** Objects to move  
Select objects: (**select**)
5. **Pick** A point to move from  
Base point or displacement: (**pick point**)
6. **Pick** A point to move to  
Second point of displacement: (**pick point**)

Circle before move

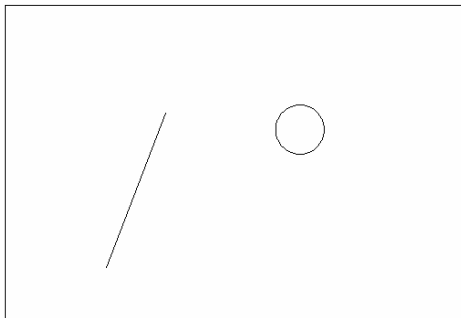

Circle after move

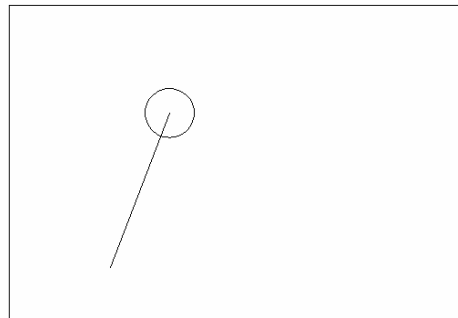

### TIP:

To move an object a specified distance, type a distance at the second point of displacement prompt: **@1<0**



# AutoCAD 2D Tutorial

---

## Copy Command 10.2

1. **Choose** Modify, Copy.  
**or**
2. **Click** the Copy icon. 
3. **Type** COPY at the command prompt.  
Command: **COPY or CP**
4. **Pick** Objects to copy.  
Select objects: (**select**)
5. **Pick** A point to move from.  
Base point or displacement/Multiple: (**pick point**).
6. **Pick** A point to copy to.  
Second point of displacement: (**pick point**)  
**or**
7. **Type** A point to copy to.  
Second point of displacement: **@ 1<0**

*Duplicate objects copied*

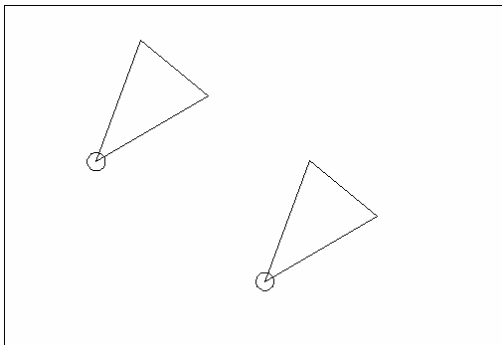

*Multiple objects copied*

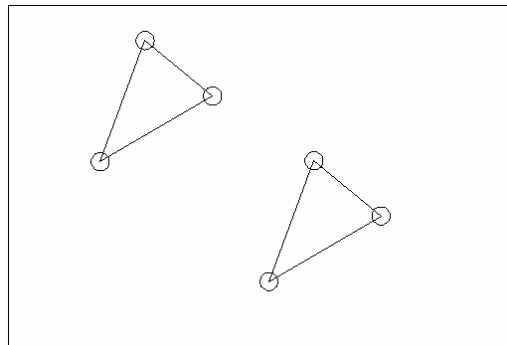

### TIP:

- To copy many objects in the same copy command, type M for Multiple at the “Base point or displacement/Multiple” option.

# AutoCAD 2D Tutorial

---

## Offset Command 10.4

### Offset Distance

To offset a specified distance:

1. **Choose** Modify, Offset.  
**or**
2. **Choose** the Offset icon.   
**or**
3. **Type** OFFSET at the command prompt.  
Command: **OFFSET** or **O**
4. **Type** The distance to offset.  
Offset distance or <Through point>: **(number)**
5. **Pick** The object to offset.  
Select object to offset: **(select object)**
6. **Pick** A side to offset object to.  
Side to offset: **(pick side)**
7. **Pick** Another object to offset  
Select object to offset: **(pick side)**  
**or**
8. **Press** Enter to end the command.

*Offsetting objects by specifying a distance*

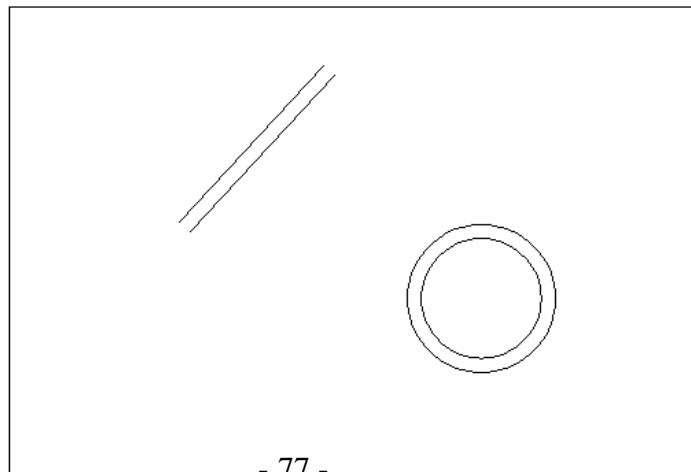

# AutoCAD 2D Tutorial

---

## Explode Command 15.4

1. **Choose** *Modify, Explode.*  
**or**
2. **Pick** the Explode icon. 
3. **Type** EXPLODE at the command prompt.  
Command: **EXPLODE**  
**or**
4. **Pick** The object to explode. Select objects: (**pick**)

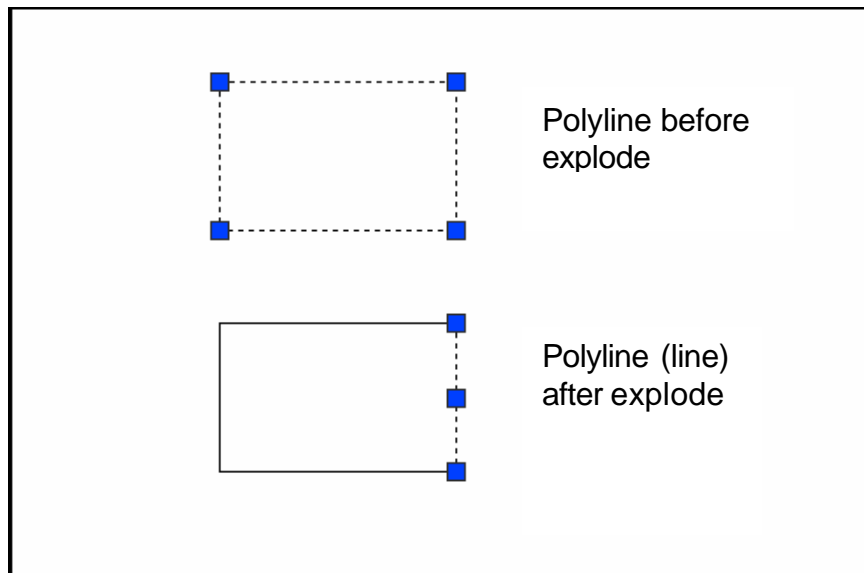

# AutoCAD 2D Tutorial

---

## EXTEND 10.5

1. **Choose** Modify, Extend.  
**or**
2. **Click** the Extend icon. 
- or**
3. **Type** EXTEND at the command prompt  
Command: **EXTEND**  
Select boundary edge(s)...
4. **Pick** The BOUNDARY edge to extend to  
Select objects: (**select**)
5. **Press** ENTER to accept the boundary edge  
Select objects: (**press enter**)
6. **Pick** The objects to extend  
<Select object to extend> / Project / Edge / Undo: Select an object, enter an option, or press enter : (**select**)
7. **Press** ENTER when you are done choosing objects

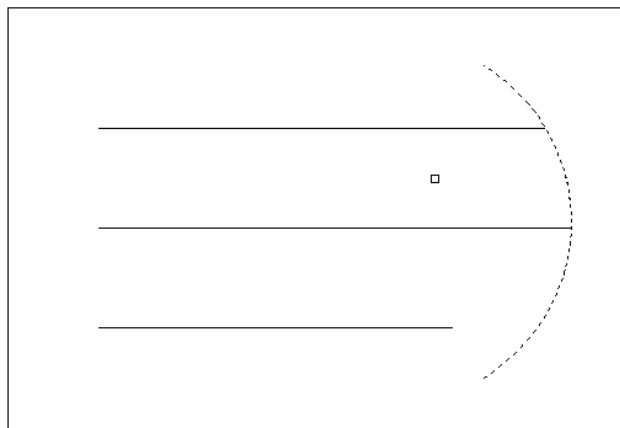

*Lines Extended  
to an Arc  
(Arc is boundary edge)*

### TIP:

- Use the object selection option FENCE to choose multiple objects

# AutoCAD 2D Tutorial

---

## Stretch 13.2

1. **Choose** Modify, Stretch.  
or
2. **Click** the Stretch icon. 
3. **Type** STRETCH at the command prompt.  
Command : **STRETCH** Select  
objects to stretch by window...
4. **Type** C to choose CROSSING window  
Select objects: **C**
5. **Pick** A first corner to stretch. First corner: **(point)**
6. **Pick** The opposite corner to window the objects to stretch.  
Other corner: **(point)**

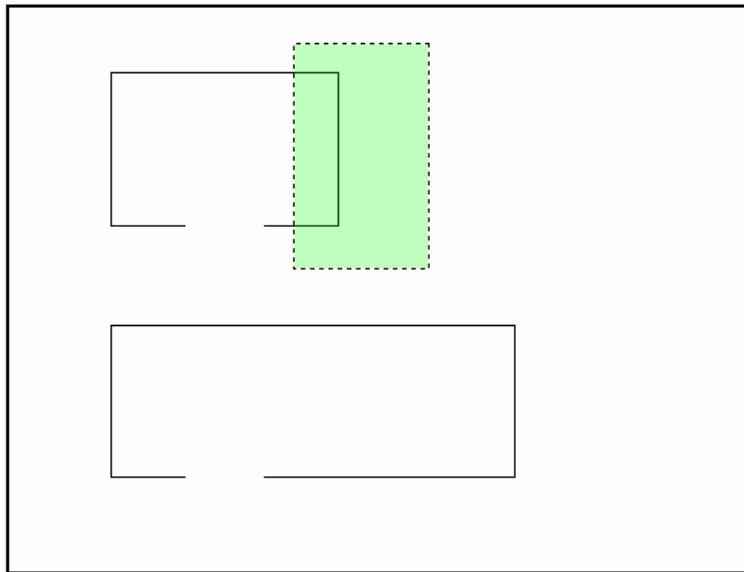

7. **Press** ENTER to accept objects to stretch.
8. **Pick** A base point to stretch from Base point:  
**(point)**



# AutoCAD 2D Tutorial

---

## TRIM 10.6

The TRIM command allows you to trim objects in a drawing so they end precisely at a cutting edge defined by one or more other objects in the drawing.

1. **Choose** Modify, Trim.  
**or**
2. **Click** the Trim icon. 
3. **Type** TRIM at the command prompt  
Command: **TRIM**  
Select cutting edge(s)...
4. **Pick** The CUTTING edge to extend to  
Select objects: (**select**)
5. **Press** ENTER to accept the cutting edge  
Select objects: (**press enter**)
6. **Pick** Objects to trim  
<Select object to trim> / Project / Edge / Undo:  
Select an object, enter an option, or press enter
7. **Press** ENTER when you are done choosing objects  
Select object to trim/Undo: (**press enter**)

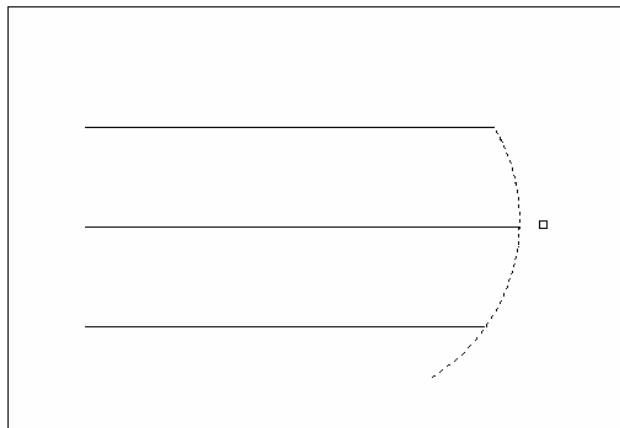

*Lines Trimmed  
to an Arc  
(Arc is cutting  
edge)*

**TIP:** Hold the SHIFT key to interactively extend instead of trim.

# AutoCAD 2D Tutorial

---

## Break 13.1

1. **Choose** Modify, Break.  
or
2. **Click** the Break icon.   
or
3. **Type** BREAK at the command prompt. Command: **BREAK**
4. **Pick** Object to break.  
Select object: (**select one object**)
5. **Pick** A second break point.  
Enter second point : (**point**)

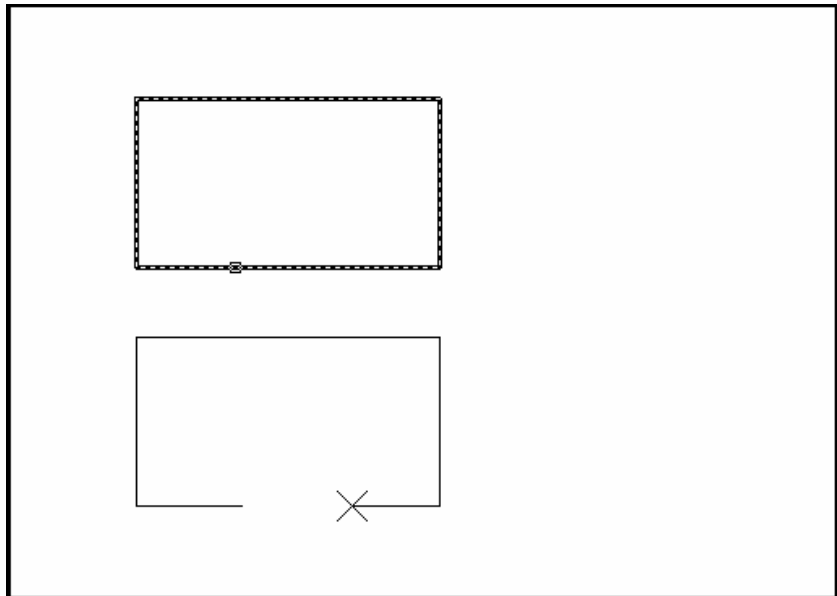

or

6. **Type** F to choose a different break point  
Enter second point (or F for first point):(**F**)



# AutoCAD 2D Tutorial

---

## MIRROR 10.7

1. **Choose** Modify, Mirror.  
**or**
2. **Click** the Mirror icon.   
**or**
3. **Type** MIRROR at the command prompt.  
Command: **MIRROR**
4. **Pick** Objects to mirror.  
Select objects:(**select**)
5. **Pick** First point of mirror line: (**point**)
6. **Pick** Second point: (**point**)
7. **Type** Yes to delete the original objects and  
No to keep them.  
Delete old objects? **Y** or **N**

Mirror Line

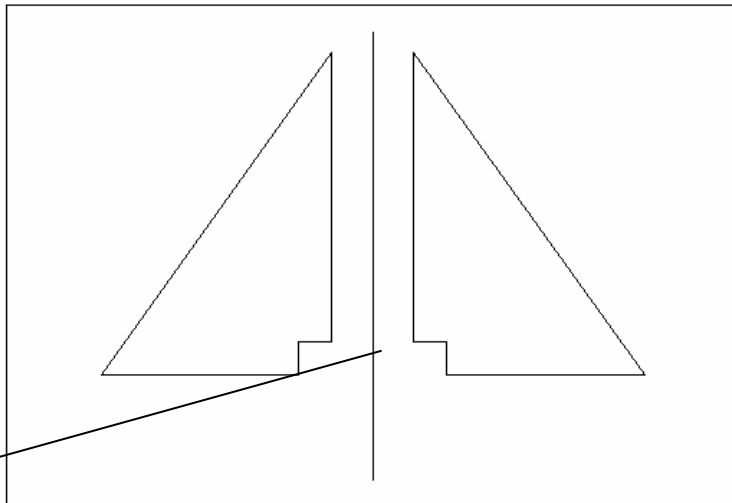

# AutoCAD 2D Tutorial

---

## ROTATE 10.9

1. **Choose** Modify, Rotate.  
**or**
2. **Click** the Modify icon.   
**or**
3. **Type** ROTATE at the command prompt  
Command : **ROTATE**
4. **Pick** Objects to rotate:  
Select objects:(**select**)
5. **Pick** A pivot point to rotate around  
Base point: (**point**)
6. **Type** A rotation angle<Rotation angle>/Reference:  
(**number**)  
**or**
7. **Pick** A rotation angle<Rotation angle>/Reference: (**point**)

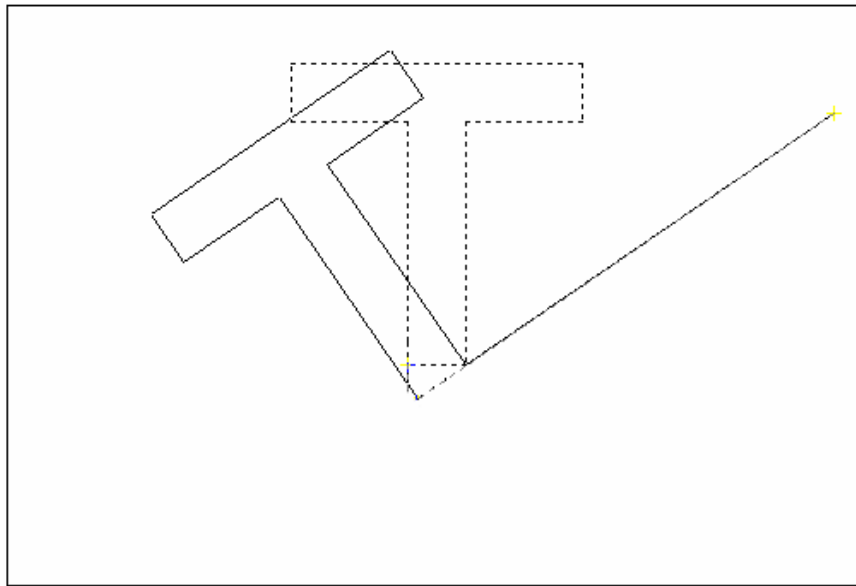

# AutoCAD 2D Tutorial

---

## SCALE 10.10

1. **Choose** Modify, Scale.  
**or**
2. **Click** the Scale icon.   
**or**
3. **Type** SCALE at the command prompt  
Command: **SCALE**  
Select objects: (**select objects**)
4. **Pick** A pivot point to scale about Base point: (**point**)
5. **Type** A rotation angle<Scale factor>/Reference:(**number**)  
**or**
6. **Pick** A scale factor<Scale factor>/Reference:  
(**point**)  
Scale factor/Reference: (**points**)

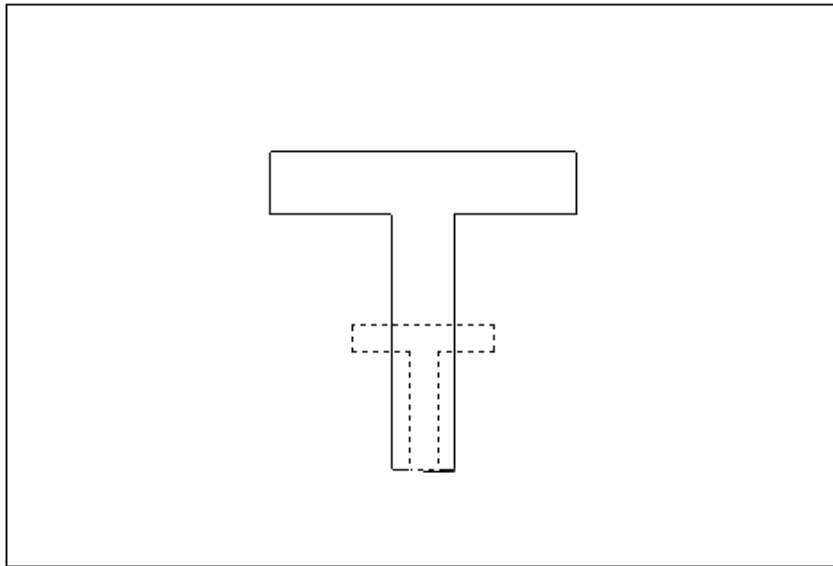

# AutoCAD 2D Tutorial

---

## Text Command 11.1

### Text

Creates a single-line text object

1. **Type** TEXT at the command prompt  
Command: **TEXT**  
**or**
2. **Pick** the Single Line Text icon from the Text Toolbar. 
3. **Pick** A start point  
Justify/Style/<Start Point>: (**point**)  
**or**
4. **Type** J to change the justification or S to change the text style.
5. **Type** A text height  
Height <default>: (**type value or pick two points**)
6. **Type** A rotation angle  
Rotation angle <default>: (**angle or point**)
7. **Type** A text string  
Text: (**type text string**)
8. **Press** enter to exit the Text: prompt.

### DTEXT (Dynamic Text)

Creates a single-line text object, showing the text dynamically on the screen as it is entered.

1. **Choose** Draw, Text, Single Line Text.  
**or**
2. **Type** DTEXT at the command prompt  
Command : **DTEXT**
3. **Follow** the steps 3-8 from above.

# Layers

# AutoCAD 2D Tutorial

## Introduction to Layers and Layer Dialog Box 12.1

1. **Choose** Format, Layer.  
**or**
2. **Type** LAYER at the command prompt.  
Command: **LAYER (or LA)**  
**or**
3. **Pick** the layers icon from the Layer Control box on the object properties toolbar.



AutoCAD 2005

Layer Properties

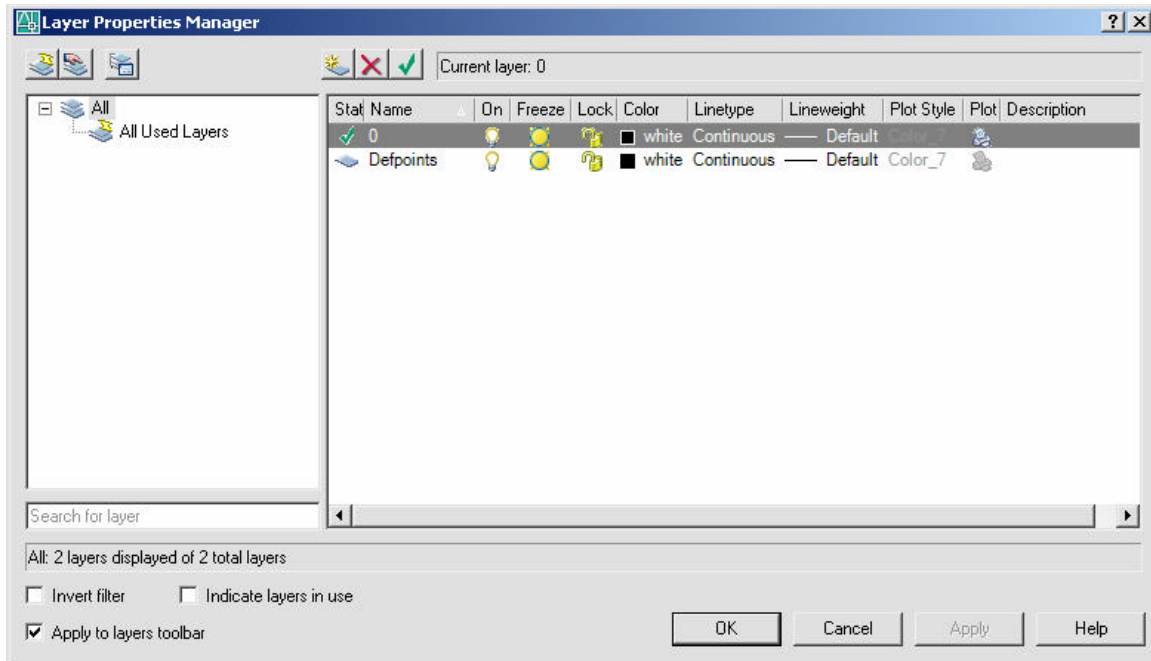

# AutoCAD 2D Tutorial

---

## Layer Options 12.2

<b>?</b>	Lists layers, with states, colors and linetypes.
<b>Make</b>	Creates a new layer and makes it current.
<b>Set</b>	Sets current layer.
<b>New</b>	Creates new layers .
<b>ON</b>	Turns on specified layers.
<b>OFF</b>	Turns off specified layers.
<b>Color</b>	Assigns color to specified layers.
<b>Ltype</b>	Assigns linetype to specified layers.
<b>Freeze</b>	Completely ignores layers during regeneration.
<b>Thaw</b>	Unfreezes specified layers Ltype.
<b>Lock</b>	Makes a layer read only preventing entities from being edited but available visual reference and osnap functions.
<b>Unlock</b>	Places a layer in read write mode and available for edits.
<b>Plot</b>	Turns a Layer On for Plotting
<b>No Plot</b>	Turns a Layer Off for Plotting
<b>LWeight</b>	Controls the line weight for each layer

### TIP:

Layers can be set using the command line prompts for layers. To use this, type -LAYER or -LA at the command prompt

1. **Type** Command: **-LAYER** or **LA**
2. **Type** One of the following layer options  
?/Make/Set/New/ON/OFF/Color/Ltype/Freeze/Thaw:

# AutoCAD 2D Tutorial

## Layer Shortcuts 12.3

### Changing the Layer of an Object

1. **Click** Once on the object to change.
2. **Select** the desired layer from the Layer Control Box dropdown.

AutoCAD will move the object to the new layer.

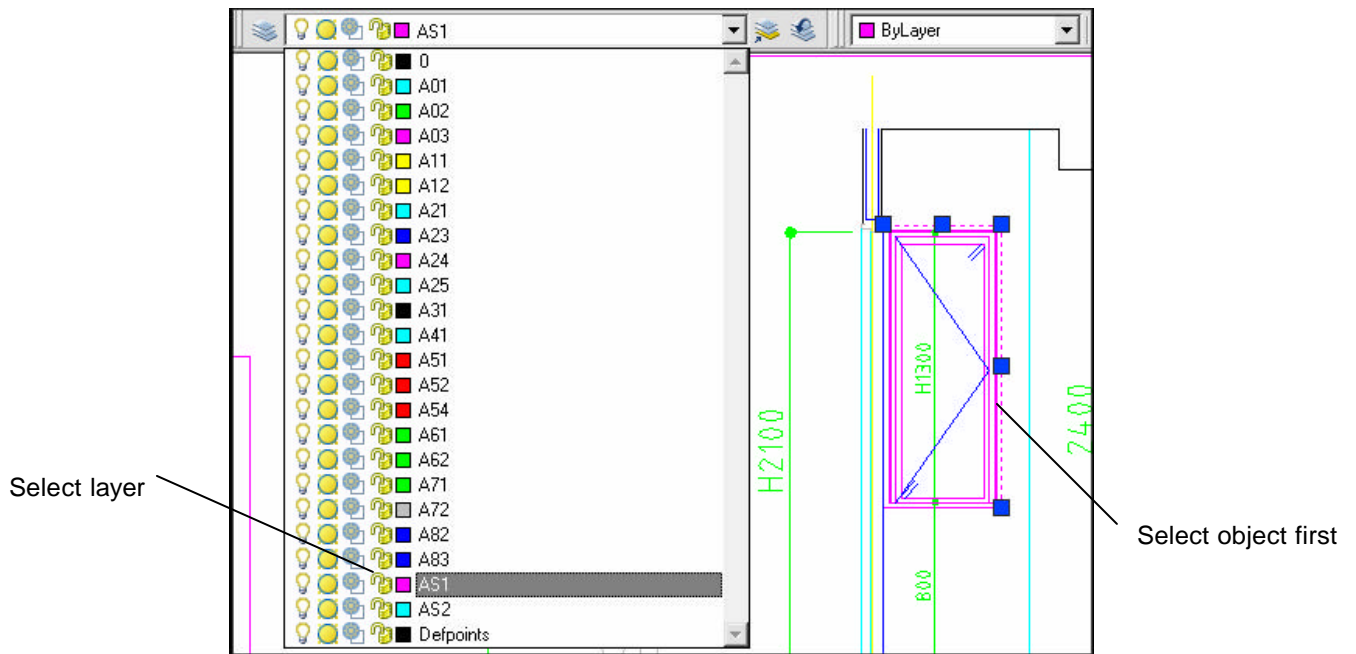



# Colours + Line Weights

# AutoCAD 2D Tutorial

---

## Color Command 12.6

1. **Choose** Format, Color.  
**or**
2. **Type** DDCOLOR at the command prompt.  
Command: **DDCOLOR or COL**  
**or**
3. **Choose** Color on the Object Properties toolbar and then select a color from the list or select Other to display the Select Color dialog box.



### TIP:

These settings ignore the current layer settings for color.

### By Layer

If you enter bylayer, new objects assume the color of the layer upon which they are drawn.

### By Block

If you enter byblock, AutoCAD draws new objects in the default color (white or black, depending on your configuration) until they are grouped into a block. When the block is inserted in the drawing, the objects in the block inherit the current setting of the COLOR command.

# AutoCAD 2D Tutorial

## Linetypes 12.7

### Loading and Changing Linetypes

1. **Choose** Format, Linetype...  
**or**
2. **Type** DDLTYPE at the command prompt.  
Command: **DDLTYPE** or **LT**
3. **Choose** Load... to see a list of available linetypes.



4. **Choose** the desired linetype to assign.

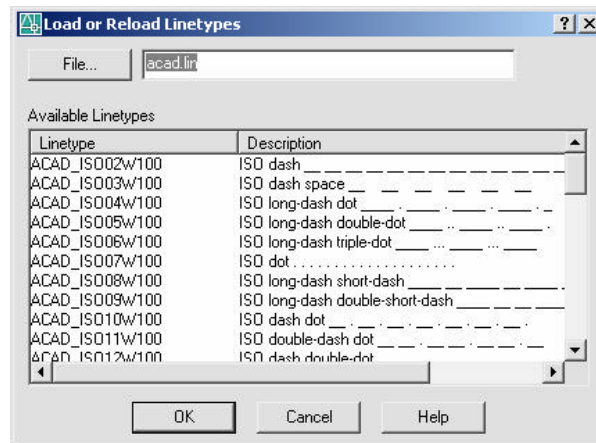

5. **Click** OK.

# AutoCAD 2D Tutorial

## Lineweights 12.8

### Loading and Changing Lineweights

1. **Choose** Format, Lineweight...
- or**
2. **Type** LINEWEIGHT at the command prompt.  
Command: **LINEWEIGHT** or **LWEIGHT**
- or**
4. **Pick** a lineweight to make current from the Object Properties menu.

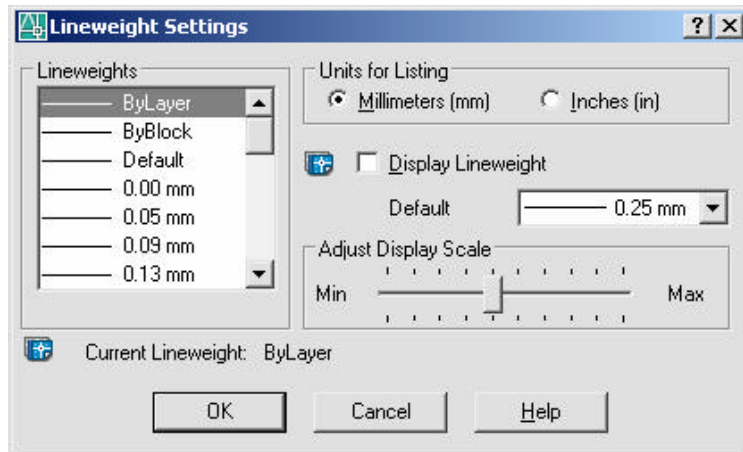

### TIPS:

- Lineweights can also be assigned to layers.
- The Display Lineweights feature can be turned on/off on the status bar to show or not show lineweights in the drawing, thus making regenerations faster.

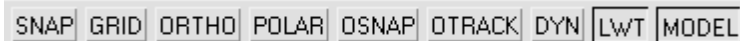

- Lineweights are displayed using a pixel width in proportion to the real-world unit value at which they plot. If you are using a high-resolution monitor, you can adjust the lineweight display scale to better display different lineweight widths.

# AutoCAD 2D Tutorial

## Object Properties 12.9

1. **Choose** Modify, Properties.  
or
2. **Click** the Properties icon.  
or 
3. **Type** DDCHPROP or DDMODIFY at the command prompt.  
Command: **DDCHPROP** (CH) or  
**DDMODIFY** (MO)
4. **Pick** Objects whose properties you want to change  
Pick a window for DDCHPROP, single object for DDMODIFY.  
Select objects:(select)
5. **Press** ENTER to accept objects.  
Select objects: (press enter)
6. **Choose** One of the following properties to change.

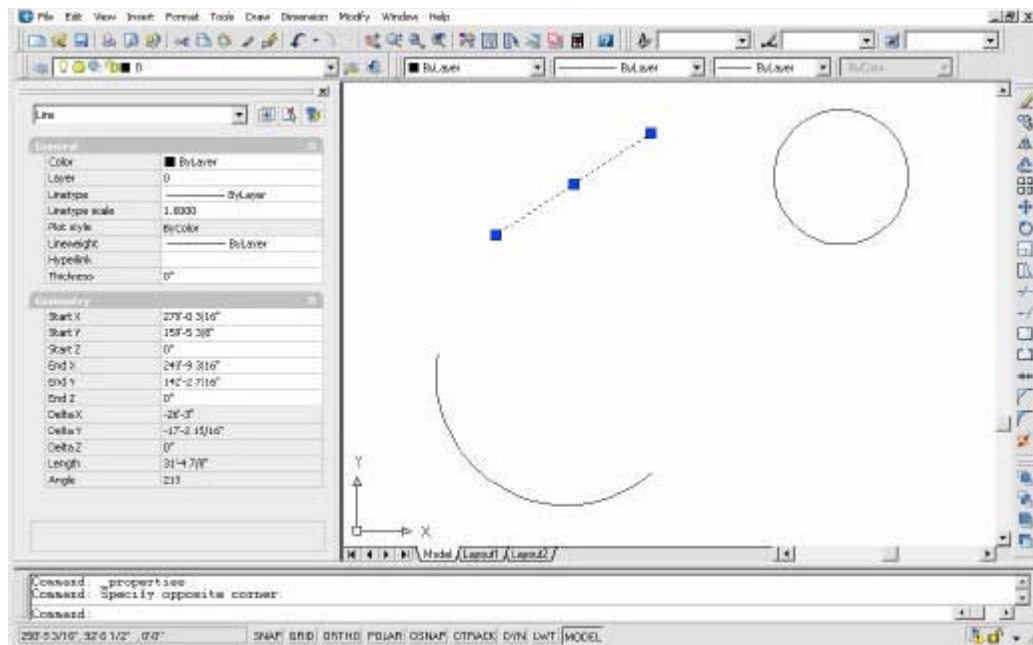

# Other Useful Functions

# AutoCAD 2D Tutorial

## BHATCH Command 17.1

1. **Choose** Draw, Hatch...  
**or**
2. **Click** the Hatchicon.   
**or**
3. **Type** BHATCH at the command prompt  
Command: **BHATCH**

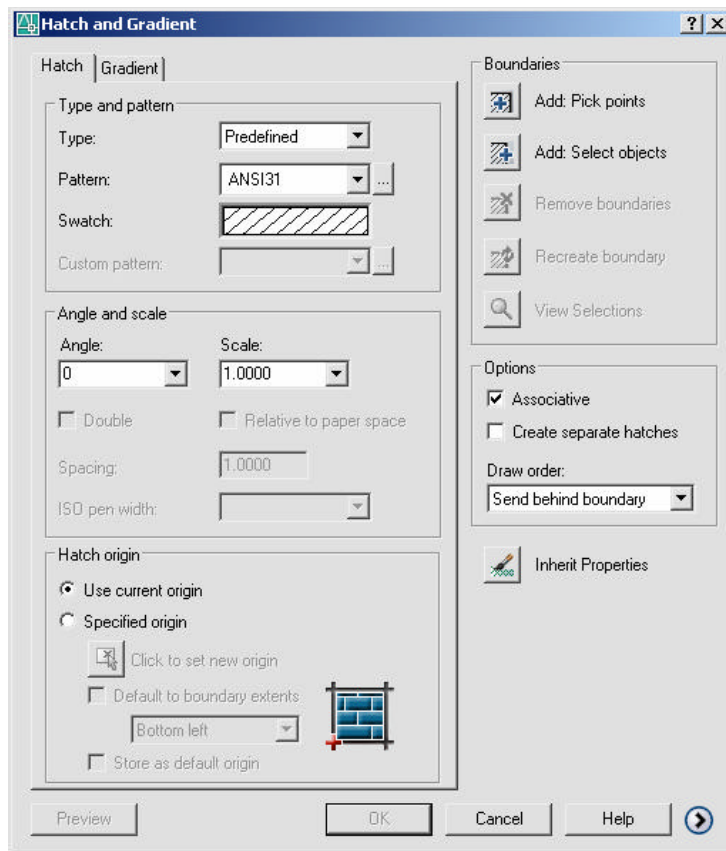

# AutoCAD 2D Tutorial

## Measuring Distances 8.2

1. **Choose** Tools, Inquiry, Distance.  
**or**
2. **Click** the Distance icon from the Inquiry Toolbar. 
- or**
3. **Type** DIST at the command prompt  
Command: **DIST**
4. **Pick** The first point to measure from  
First point: **pick point**
5. **Pick** The second point to measure to  
Second point: **pick point**

Distance Between Circle Centers

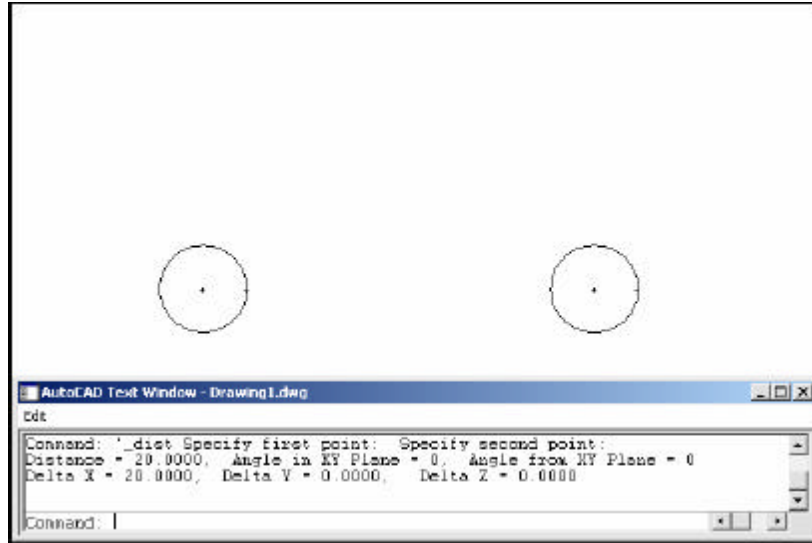

### TIP:

Be sure to use Object Snaps with the MEASURE command.



# AutoCAD 2D Tutorial

## Linear Dimensions 26.1

1. **Choose** Dimension, Linear.  
**or**
2. **Click** the Linear Dimension command from the toolbar.



3. **Type** DIM at the command prompt.  
**or**  
DIM at the command prompt.  
Command: **DIM**  
Dim: HOR or VER

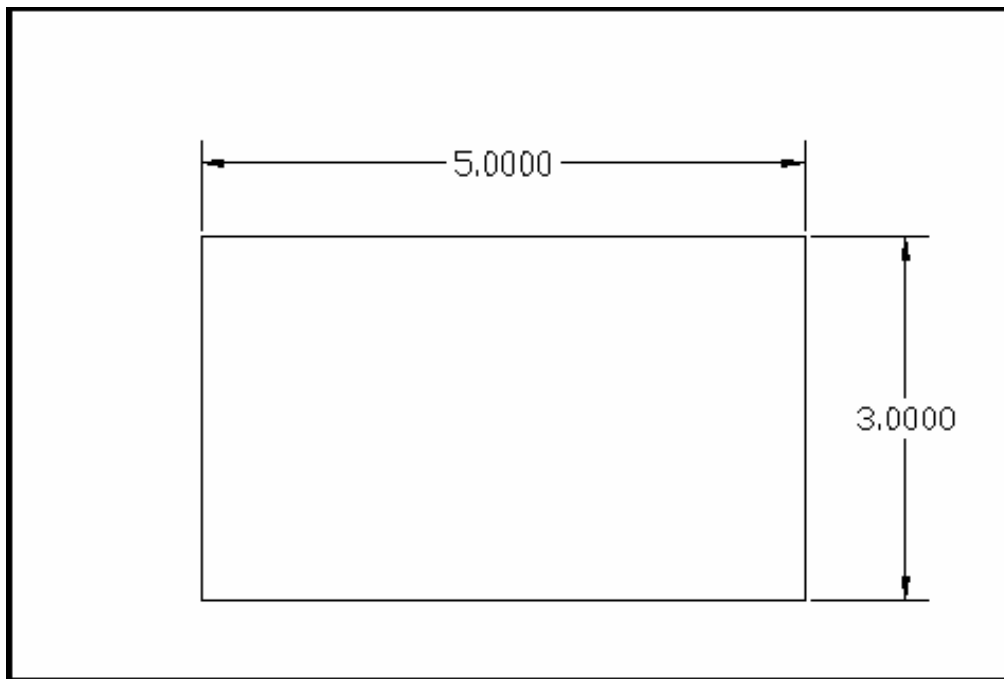

## AutoCAD 2D Tutorial

---

### Aligned Dimensions 26.2

1. **Choose** Dimension, Aligned.  
**or**
2. **Click** the Aligned Dimension command from the toolbar.

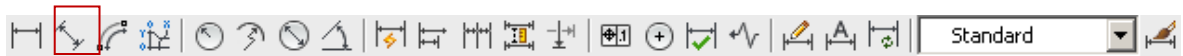

3. **Type** DIM at the command prompt.  
**or**  
DIM at the command prompt.  
Command: **DIM**  
Dim: **ALIGNED**

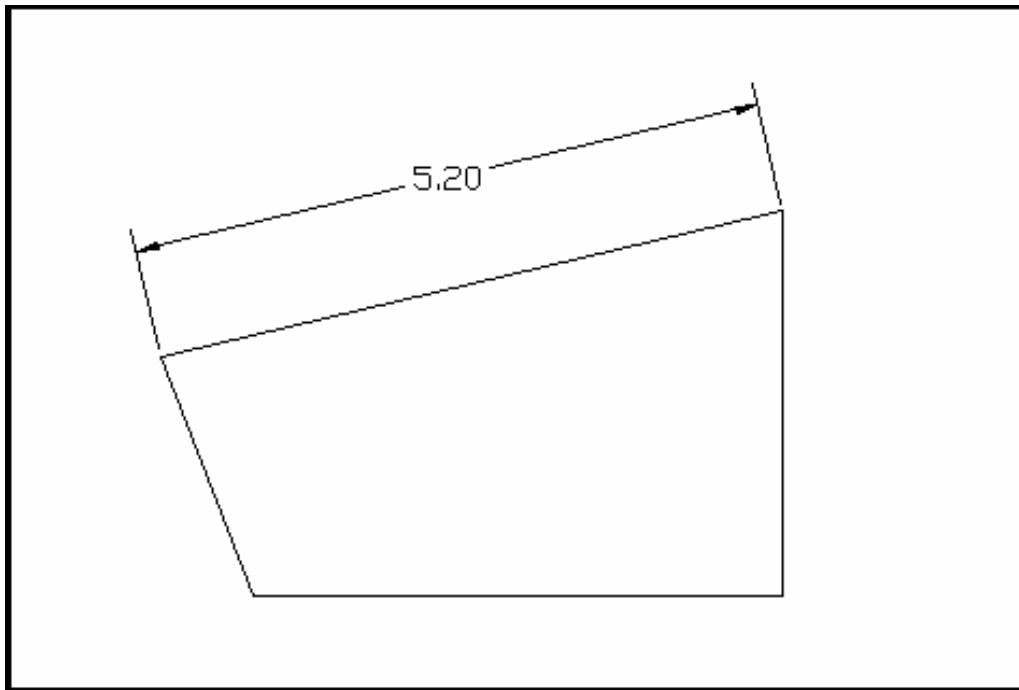

# AutoCAD 2D Tutorial

---

## Radial Dimensions 26.3

1. **Choose** Dimension, Radius or Diameter.  
**or**
2. **Click** the Radial Dimensions command from the toolbar.



3. **Type** DIM at the command prompt.  
**or**  
DIM at the command prompt.  
Command: **DIM**  
Dim: **RADIUS or DIAMETER**

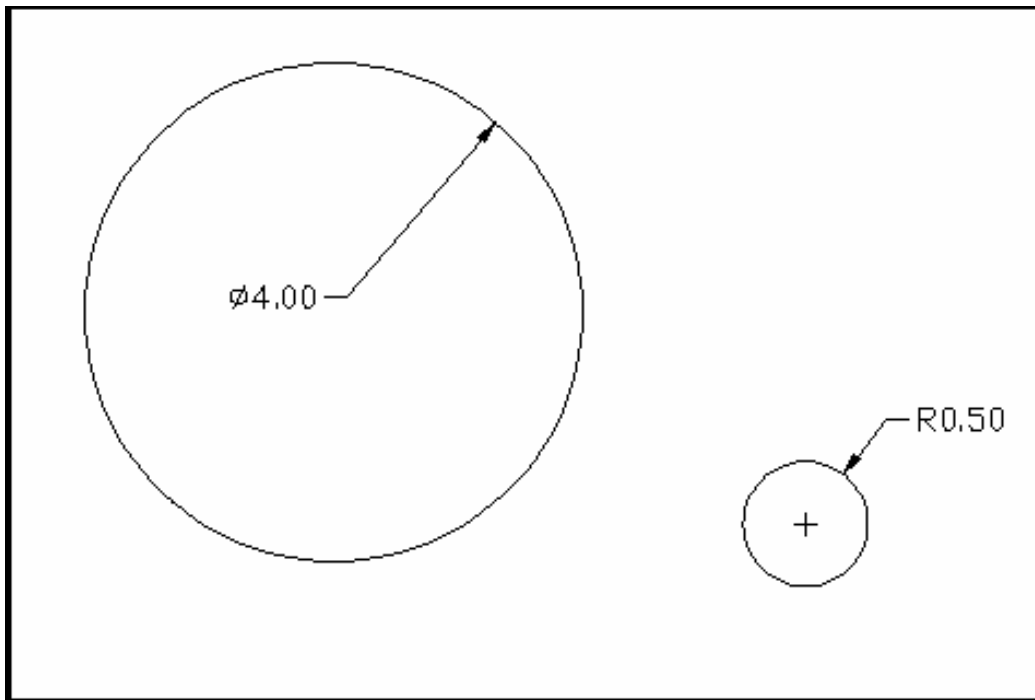

# AutoCAD 2D Tutorial

## Calculating Areas 8.3

1. **Choose** Tools, Inquiry, Area.  
or
2. **Click** the Area icon. 
- or
3. **Type** AREA at the command prompt  
Command: **AREA**
4. **Pick** The first point for area calculation  
<First point>/Object/Add/Subtract: **pick**
5. **Pick** Next point: **pick**
6. **Pick** Next point: **pick**
7. **Press** ENTER when you are finished choosing points.  
Area of Rectangle

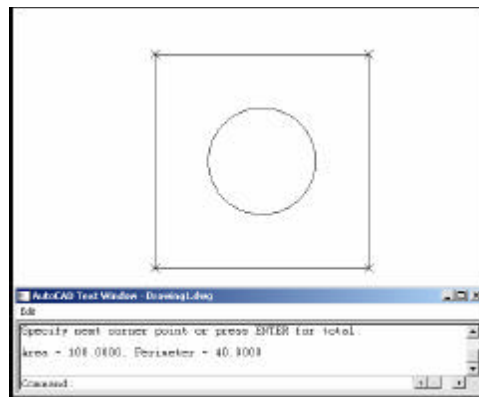

- Object** Allows user to pick an object to calculate area (circle or polyline).
- Add** Adds separate areas for a total area calculation
- Subtract** Subtracts areas from each other.

### TIPS:

Be sure to use Object Snaps with the MEASURE command

To subtract an area, you must first be in “add” mode to add the first area.

# AutoCAD 2D Tutorial

## Plot Settings

1. **Choose** the Plot Settings tab.
2. **Choose** the appropriate paper size based on the chosen plotter.
3. **Choose** the paper units (inches or mm).
4. **Choose** the drawing orientation (Portrait, Landscape, Upside down).
5. **Choose** the plotting area.
6. **Choose** the plot scale.
7. **Choose** plot to center or specify an x or y offset.
8. **Click** OK.

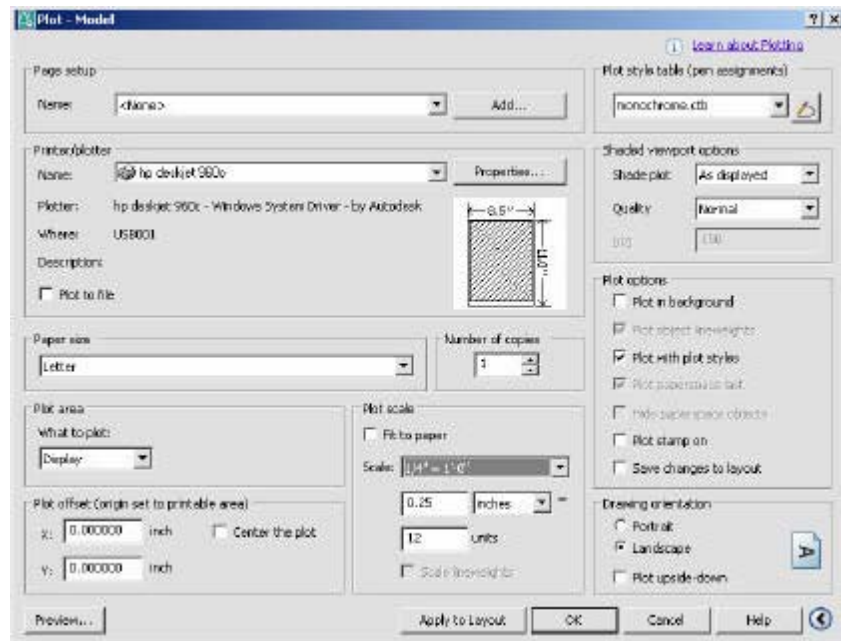

# 1.13 On-Line Help

1. Choose Help, AutoCAD Help.  
or
2. Click the Help icon. 
- or
3. Type HELP at the command prompt  
Command: **HELP**  
or
4. Press **Function Key F1**

